

USWater[™]
systems.com

US Water Defender Whole House RO System

224-DFWHRO-XXXX



Table of Contents

Unpacking / Inspection	3
Safety Guide	3
Proper Installation	4
Component Identification	6
Specifications	12
Rejection, Recovery & Flow Rates	17
System Connections, Requirements and Guidelines	18
Electrical Connections	22
Pre-Filtration	23
Pump	23
Membranes	23
UV Light Sleeve and Bulb	24
Membrane Element	26
Tank Level and Pre-treatment Lockout Wiring	28
Anti-Scalant Filling and Settings	31
RO Start-Up	34
75% Recovery System Adjustment	35
Operating Do's and Don'ts	37
Low Pressure Switch	38
Pump Throttle Valve	38
Adjusting Throttle Valve	39
Membrane Removal & Replacement	40
Membrane Flow Overview	43
Temperature Correction Factors For Membranes	47
Replacing the Lamp	49
Cleaning/Replacing the Quartz Sleeve	50
System Flow Diagram	51
Typical System Layout	55
Controller Programming Options	56
Electrical Schematic	60
Glossary of Terms	61
Warranty	63

Unpacking / Inspection

Be sure to check the entire RO system for any shipping damage or parts loss. Also note damage to the shipping cartons. Contact US Water Systems at 1-800-608-8792 to report any shipping damage within **24 hours** of delivery. Claims made after 24 hours may not be honored.

Safety Guide

- Check and comply with your provincial / state and local codes. You must follow these guidelines
- Use care when handling the RO system.
- The RO System works on **220 volt - 60 Hz 1PH** electrical power only.
- **DO NOT** exceed 150 psi on the pump or membrane pressure gauge. Damage or injury could occur as a result of excessive pressure.

Proper Installation

This RO system must be properly installed and located in accordance with the Installation Instructions before it is used or the warranty will be void.

- **Do not** install or store where it will be exposed to temperatures below freezing or exposed to any type of weather. Water freezing in the system will break it. Do not attempt to treat water over 100°F.



- **Do not** install in direct sunlight. Excessive sun or heat may cause distortion or other damage to non-metallic parts.



- Properly ground to conform with all governing codes and ordinances. Use only *lead-free solder and flux* for all sweat-solder connections, as required by state federal codes.



- Maximum allowable inlet water pressure is **125 psi**. If daytime pressure is over 80 psi, night time pressure may exceed the maximum. Use a pressure reducing valve (PRV) to reduce the pressure.



- RO membranes will degrade in the presence of chlorine or chloramines. In these conditions, it is wise to consider purchasing a carbon filter system with a chlorine reducing media. Contact US Water Systems for chlorine and chloramine removal equipment.



- **Warning:** Discard all unused parts and packaging material after installation. Small parts remaining after the installation could be a choke hazard.



**Discard All
Unused Material**

Component Identification

1. Solenoid Valve - Turns ON/OFF Feed Water Supply when the tank input circuit is opened.



2. 5 Micron Sediment Pre-Filter - Removes Sediment from the Feed Water



3. Pre-Filter Pressure Gauge - Monitors Feed Water Pressure prior to the Pre-Filter



4. Pump Pressure Gauge - Monitors the Membrane/Pump pressure during operation. **WARNING! Do not exceed 150 psi.**



5. Computer Control - The US100 Controls ON/OFF Function as well as Fail Safe Switches.



7. Concentrate/Waste Valve - Controls the amount of Concentrate Water going to the drain for waste.

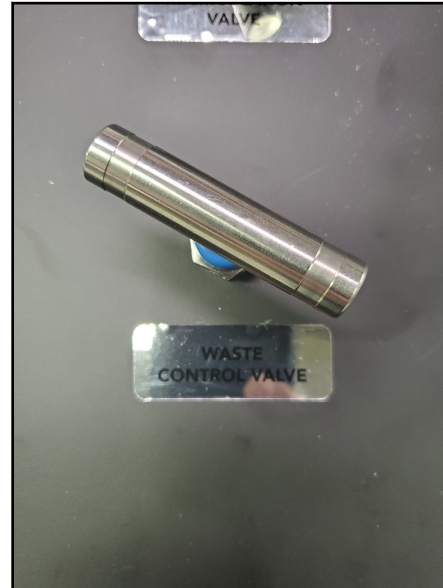

6. Recycle/Recirculation Valve - Controls the amount of Concentrate Water that is fed back to the Membranes for Re-cycle.

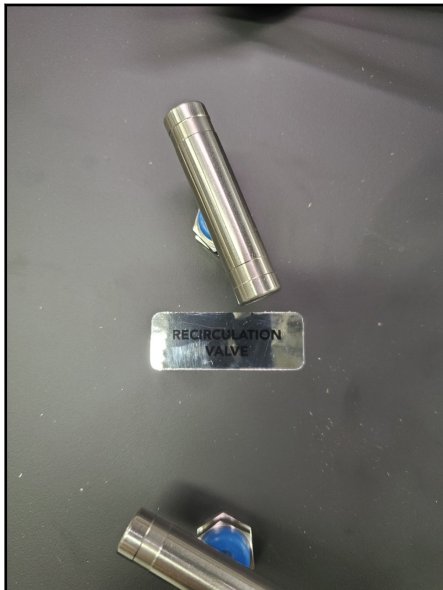

8. Pump and Motor - Boosts the Feed Water Pressure to the Membranes.



9. Throttle Valve - Adjusts the Boost Pressure to the Membranes. **WARNING! Do not exceed 150 psi.**



11. Concentrate Flow Meter - Monitors the amount of Concentrate Water going to drain.



10. Permeate/Product Flow Meter - Monitors the amount of Permeate Water going to the storage or distribution system.



12. Recycle/Recirculation Flow Meter - Monitors the amount of Concentrate Water being recycled to the Membranes.

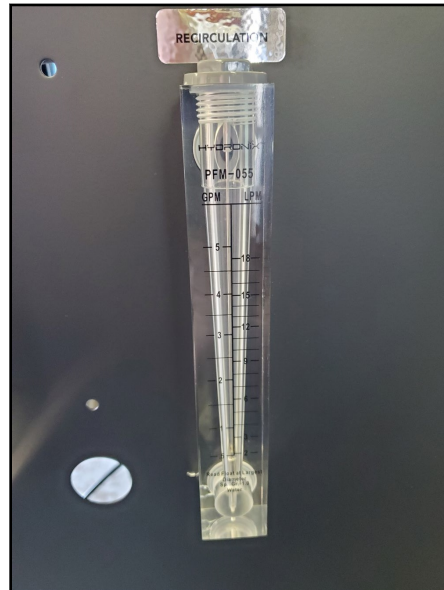

13. Low Pressure Switch - Shuts the system down as a fail safe in a Low Feed Water Pressure Condition. This pressure switch is in the RO Controller.



14. Membrane Pressure Vessels - Holds the Membranes.



15. Power Supply Cord



16. Injection Pump Electrical Connection



17. Tank Level or Pressure Shutoff and Pre-treatment Lockout Connections. **WARNING! This input is a NO VOLT-AGE dry contact. DO NOT apply voltage to this input!**

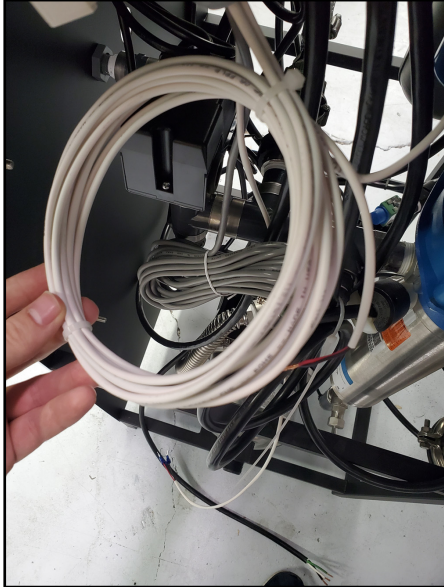

18. Re-pressurization Pump - Pressurizes the water from the Storage Tank to supply the plumbing distribution system.



19. UV Light - Used to destroy bacteria that may be in the water prior to the plumbing system. (Final Connection to Plumbing Distribution System marked as "a")



20. UV Controller - Monitors the UV light performance and bulb life.



Specifications

Table 1. DFWHRO-2000

Design		Vessels	
Configuration	Single Pass	Vessel Array	1
Feed Water Source	City or Well Water	Vessel Quantity	1
Standard Recovery Rate	31.5%		
Recovery with Concentrate Recycle	Up to 75%		
Rejection and Flow Rates		Pumps	
Nominal Salt Rejection %	98.5	Pump Type	Multi-Stage
Permeate Flow* gpm (lpm)	1.38 (5.22)	Motor HP (kw)	1.5 (1.10)
Minimum Feed Flow gpm (lpm)	4.38 (16.62)	RPM @ 60 (50Hz)	3450 (2900)
Maximum Feed Flow gpm (lpm)	6.00 (22.70)		
Minimum Concentrate Flow gpm (lpm)	3.00 (11.36)		
Connections		Electrical	
Feed inch	1 FNPT	Voltage	220V 60Hz 1PH
Permeate Inch	1/2" Tubing	Voltage Amp Draw	8.3
Concentrate Inch	1/2" Tubing		
Membranes		System Dimensions	
Membrane Per Vessel	1	L x W x H inch (cm)	32" x 25" x 65" (81.28 x 62.5 x 165.1)
Membrane Quantity	1	Weight lb. (kg)	300 (136)
Membrane Size	4" x 40" (4040)		
Operating Limits			
Maximum Feed Temperature °F (°C)	105 (40.96)	Maximum Free Chlorine ppm	0
Minimum Feed Temperature °F (°C)	40 (4.44)	Maximum TDS ppm	2000
Maximum Ambient Temperature °F (°C)	120 (48.89)	Maximum Hardness gpg	< 1
Minimum Ambient Temperature °F (°C)	35 (1.66)	Maximum pH (Continuous)	11
Maximum Feed Pressure psi (bar)	85 (5.86)	Minimum pH (Continuous)	3
Minimum Feed Pressure psi (bar)	35 (2.41)	Maximum pH (Cleaning 30 Min)	12
Maximum Operating Pressure psi (bar)	150 (10.34)	Minimum pH (Cleaning 30 Min)	2
Maximum SDI Rating	< 3		
Maximum Turbidity NTU	1		

Table 2. DFWHRO-4000

Design		Vessels	
Configuration	Single Pass	Vessel Array	1:1
Feed Water Source	City or Well Water	Vessel Quantity	2
Standard Recovery Rate	48%		
Recovery with Concentrate Recycle	Up to 75%		
Rejection and Flow Rates		Pumps	
Nominal Salt Rejection %	98.5	Pump Type	Multi-Stage
Permeate Flow* gpm (lpm)	2.78 (10.52)	Motor HP (kw)	1.5 (1.10)
Minimum Feed Flow gpm (lpm)	5.78 (21.88)	RPM @ 60 (50Hz)	3450 (2900)
Maximum Feed Flow gpm (lpm)	9.00 (34.07)		
Minimum Concentrate Flow gpm (lpm)	3.00 (11.36)		
Connections		Electrical	
Feed inch	1 FNPT	Voltage	220V 60Hz 1PH
Permeate Inch	1/2" Tubing	Voltage Amp Draw	8.3
Concentrate Inch	1/2" Tubing		
Membranes		System Dimensions	
Membrane Per Vessel	1	L x W x H inch (cm)	32" x 25" x 65" (81.28 x 62.5 x 165.1)
Membrane Quantity	2	Weight lb. (kg)	340 (154.2)
Membrane Size	4" x 40" (4040)		
Operating Limits			
Maximum Feed Temperature °F (°C)	105 (40.96)	Maximum Free Chlorine ppm	0
Minimum Feed Temperature °F (°C)	40 (4.44)	Maximum TDS ppm	2000
Maximum Ambient Temperature °F (°C)	120 (48.89)	Maximum Hardness gpg	< 1
Minimum Ambient Temperature °F (°C)	35 (1.66)	Maximum pH (Continuous)	11
Maximum Feed Pressure psi (bar)	85 (5.86)	Minimum pH (Continuous)	3
Minimum Feed Pressure psi (bar)	35 (2.41)	Maximum pH (Cleaning 30 Min)	12
Maximum Operating Pressure psi (bar)	150 (10.34)	Minimum pH (Cleaning 30 Min)	2
Maximum SDI Rating	< 3		
Maximum Turbidity NTU	1		

Table 3. DFWHRO-6000

Design		Vessels	
Configuration	Single Pass	Vessel Array	1:1:1
Feed Water Source	City or Well Water	Vessel Quantity	3
Standard Recovery Rate	58%		
Recovery with Concentrate Recycle	Up to 75%		
Rejection and Flow Rates		Pumps	
Nominal Salt Rejection %	98.5	Pump Type	Multi-Stage
Permeate Flow* gpm (lpm)	4.16 (15.80)	Motor HP (kw)	1.5 (1.10)
Minimum Feed Flow gpm (lpm)	7.16 (27.20)	RPM @ 60 (50Hz)	3450 (2900)
Maximum Feed Flow gpm (lpm)	14.00 (53.00)		
Minimum Concentrate Flow gpm (lpm)	3.00 (11.36)		
Connections		Electrical	
Feed inch	1 FNPT	Voltage	220V 60Hz 1PH
Permeate Inch	1/2" Tubing	Voltage Amp Draw	8.3
Concentrate Inch	1/2" Tubing		
Membranes		System Dimensions	
Membrane Per Vessel	1	L x W x H inch (cm)	32" x 25" x 65" (81.28 x 62.5 x 165.1)
Membrane Quantity	3	Weight lb. (kg)	370 (167.83)
Membrane Size	4" x 40" (4040)		
Operating Limits			
Maximum Feed Temperature °F (°C)	105 (40.96)	Maximum Free Chlorine ppm	0
Minimum Feed Temperature °F (°C)	40 (4.44)	Maximum TDS ppm	2000
Maximum Ambient Temperature °F (°C)	120 (48.89)	Maximum Hardness gpg	< 1
Minimum Ambient Temperature °F (°C)	35 (1.66)	Maximum pH (Continuous)	11
Maximum Feed Pressure psi (bar)	85 (5.86)	Minimum pH (Continuous)	3
Minimum Feed Pressure psi (bar)	35 (2.41)	Maximum pH (Cleaning 30 Min)	12
Maximum Operating Pressure psi (bar)	150 (10.34)	Minimum pH (Cleaning 30 Min)	2
Maximum SDI Rating	< 3		
Maximum Turbidity NTU	1		

Table 4. DFWHRO-8000

Design		Vessels	
Configuration	Single Pass	Vessel Array	1:1:1:1
Feed Water Source	City or Well Water	Vessel Quantity	4
Standard Recovery Rate	65%		
Recovery with Concentrate Recycle	Up to 75%		
Rejection and Flow Rates		Pumps	
Nominal Salt Rejection %	98.5	Pump Type	Multi-Stage
Permeate Flow* gpm (lpm)	5.56 (21.13)	Motor HP (kw)	1.5 (1.10)
Minimum Feed Flow gpm (lpm)	8.56 (32.53)	RPM @ 60 (50Hz)	3450 (2900)
Maximum Feed Flow gpm (lpm)	14.00 (53.00)		
Minimum Concentrate Flow gpm (lpm)	3.00 (11.36)		
Connections		Electrical	
Feed inch	1" FNPT	Voltage	220V 60Hz 1PH
Permeate Inch	1/2" Tubing	Voltage Amp Draw	8.3
Concentrate Inch	1/2" Tubing		
Membranes		System Dimensions	
Membrane Per Vessel	1	L x W x H inch (cm)	32" x 25" x 65" (81.28 x 62.5 x 165.1)
Membrane Quantity	4	Weight lb. (kg)	400 (181.44)
Membrane Size	4" x 40" (4040)		
Operating Limits			
Maximum Feed Temperature °F (°C)	105 (40.96)	Maximum Free Chlorine ppm	0
Minimum Feed Temperature °F (°C)	40 (4.44)	Maximum TDS ppm	2000
Maximum Ambient Temperature °F (°C)	120 (48.89)	Maximum Hardness gpg	< 1
Minimum Ambient Temperature °F (°C)	35 (1.66)	Maximum pH (Continuous)	11
Maximum Feed Pressure psi (bar)	85 (5.86)	Minimum pH (Continuous)	3
Minimum Feed Pressure psi (bar)	35 (2.41)	Maximum pH (Cleaning 30 Min)	12
Maximum Operating Pressure psi (bar)	150 (10.34)	Minimum pH (Cleaning 30 Min)	2
Maximum SDI Rating	< 3		
Maximum Turbidity NTU	1		

*Product Flow Rates are based on equipment test parameters. ** Does not include operating space requirements

Test Parameters: 550 TDS Filtered (5 Micron), De-Chlorinated, Softened City Feed Water, 35 psi (2.41 bar) Feed Pressure, 150 psi (10.34 Bar) (HF4 Membranes), 70 psi (4.83 bar) Operating Pressure, 77 Degrees F (25 Degrees C), Recover as stated, 7.0 pH. Data taken after 30 minutes of operation. Low temperatures and high TDS levels will significantly affect system's production capabilities. Computer projections should be run for individual applications which do not meet or exceed minimum and maximum operating limits.

Rejection, Recovery & Flow Rates

The US Water Systems Defender reverse osmosis system is designed to produce permeate water at the capacities indicated by the suffix in the systems name under the conditions listed above. For example, the DFWHRO-4000 produces 4000 gallons per day of permeate water at the listed operating test conditions.

The amount of total dissolved solids (TDS) rejected by the membrane is expressed as a percentage. For example, a 98.5% rejection rate means that 98.5% of total dissolved solids do not pass through the membrane. To calculate the % rejection, use the following formula:

- **% Rejection = [(Feed TDS - Product TDS) / Feed TDS] x 100**
- Example: 98.5% = [(550 - 8.25) / 550] x 100

NOTE: ALL TDS FIGURES MUST BE EXPRESSED IN THE SAME UNITS, TYPICALLY PARTS PER MILLION (PPM) OR MILLIGRAMS PER LITER (MG/L).

The Defender reverse osmosis system is designed to reject up to 98.5% NaCl, unless computer projections have been provided or stated otherwise.

The amount of permeate water recovered for use is expressed as a percentage. To calculate % recovery, use the following formula:

- **% Recovery = (Product Water Flow Rate / Feed Water Flow Rate) x 100**
- Example: 40% = (2.78 / 7.0) x 100

NOTE: ALL FLOW RATES MUST BE EXPRESSED IN THE SAME UNITS, TYPICALLY GALLONS PER MINUTE (GPM).

System Connections, Requirements and Guidelines

PLUMBING

The membranes and high pressure pumps used on Defender systems require a continuous flow of water with a minimum feed pressure of 35 psi, not to exceed 105°F while the system is running.

FEED WATER CONNECTION

1. Locate the 1" FNPT inlet connection on the sediment filter housing.
2. Attach the inlet piping to the 1" FNPT Filter housing inlet.

NOTE: FEED LINE MUST BE MINIMUM 3/4".



PERMEATE (PRODUCT WATER) CONNECTION

1. Locate the 1/2" tubing labeled permeate and attach to the bulkhead in the top of the storage tank. Ensure that the permeate water can flow freely with no back pressure. Back pressure can cause irreversible damage to the membrane elements.

NOTE: ALL PERMEATE PLUMBING SHOULD BE DONE WITH PLASTIC OR STAINLESS STEEL. SOFT METALS WILL LEACH INTO THE WATER STREAM. CPVC, PVC, PEX AND STAINLESS STEEL ARE THE MOST COMMONLY USED MATERIAL.

CAUTION: THE PH OF THE REVERSE OSMOSIS PERMEATE WATER WILL TYPICALLY BE 1-2 POINTS LOWER THAN THE FEED WATER PH. A LOW PH CAN BE VERY AGGRESSIVE TO SOME PLUMBING MATERIALS SUCH AS COPPER PIPING.

CONCENTRATE (WASTE WATER) CONNECTION

1. Locate the 1/2" tubing labeled concentrate and attach/convey to a drain. Run the concentrate line to an open drain in a free and unrestricted manner (no back pressure). It is recommended that an air gap be maintained on the drain line to prevent possible bacterial contamination.

CAUTION: ANY RESTRICTIONS OR BLOCKAGE IN THE DRAIN LINE CAN CAUSE BACK PRESSURE, WHICH WILL INCREASE THE SYSTEMS OPERATING PRESSURE. THIS CAN RESULT IN DAMAGE TO THE SYSTEMS MEMBRANES AND COMPONENTS.

RE-PRESSURIZATION PUMP CONNECTION

1. Apply Teflon tape to the supplied 1" stainless steel nipple and install into the bulk-head located at the bottom of the atmospheric storage tank. Tighten using two pairs of channel locks. Then install the supplied ball valve using the same method. Locate the 1" male threaded connection on the re-pressurization pump and attach the piping from the bottom of the storage tank. Do not turn the pump on at this point.

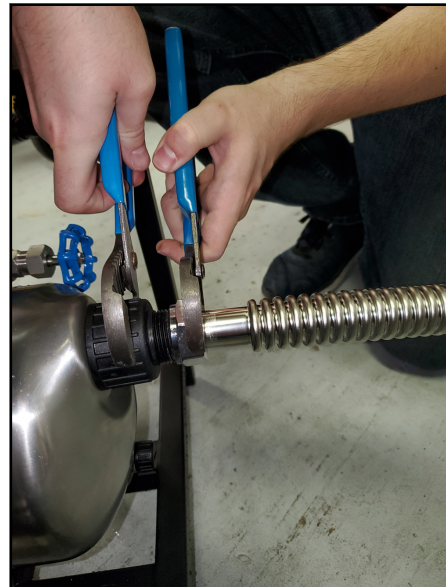

PLUMBING DISTRIBUTION SYSTEM CONNECTION

1. Locate the 1" male threaded connection on the UV light chamber and connect piping to the plumbing distribution system.



Electrical Connections

Main System Power

The main power on the Defender system is available in **220 volt, 60 Hertz, 1 Phase**. Each Defender system is equipped with a 5 foot electrical cord. This can be hardwired in a disconnect box or an outlet box can be installed that matches the cord end for the respective voltage. This should be powered by an isolated 20 amp breaker.

Re-Pressurization Pump

The re-pressurization pump requires **110 Volt, 60 Hertz, 1 Phase**. This should be connected to a constantly energized 110 Volt outlet. The pump is equipped with a standard 110 Volt cord end.

UV Light Controller

The UV Light Controller requires **110 Volt, 60 Hertz, 1 Phase**. This should be connected to a constantly energized 110 Volt outlet.

IMPORTANT NOTICES

WARNING: To prevent possible circuit overload, it is best to run isolated circuits to supply the RO system and the UV Light and Re-pressurization pump

The RO system should have a 20 Amp Breaker. The UV Light and Re-pressurization pump can share a 20 Amp Breaker.

NOTE: It is recommended that a licensed electrician wire the system in accordance with the local and national electrical codes.

WARNING: To reduce the risk of electrical shock, the incoming power supply must include a protective earth ground.

NOTE: If the anti-scalant option was purchased, the injection check valve that comes with the anti-scalant pump should be put in the injection tee on the booster pump inlet plumbing. There is a 1/2" plug that must be removed and the injection check valve can be installed.

BE SURE to Teflon tape the injection check valve threads before installing it in the tee fitting.

Pre-Filtration

The Defender systems do not include pre-filtration. It is **VERY** important to have pre-filtration before the RO system to ensure longevity and that damage will not occur to the unit. A water test of the feed water is used to determine the proper pre-treatment equipment. Contact **US Water Systems** for help determining what pre-treatment equipment is required.

NOTE: THE SYSTEM MUST BE OPERATED ON FILTERED WATER ONLY. 99.9% OF ALL RO APPLICATIONS REQUIRE SOME FORM OF PRE-TREATMENT. SYSTEMS OPERATED USING UNTREATED WATER WILL HAVE PREMATURE MEMBRANE FAILURES. MEMBRANE FAILURES DUE TO IMPROPER PRE-TREATMENT ARE NOT COVERED UNDER WARRANTY

Pump

The pump type used on the Defender systems is a multi-stage centrifugal carbon steel pump.

Follow these guidelines to ensure proper operation of the pump:

- The pump must **NEVER** be run dry. Operating the pump without sufficient feed water will damage the pump.
- **ALWAYS** feed the pump with filtered water. The pump is susceptible to damage from sediment and debris.

NOTE: THE FEED WATER PRESSURE MUST NOT FALL BELOW 30 PSI WHILE THE SYSTEM IS RUNNING. THE SYSTEM WILL SHUTDOWN FOR A LOW PRESSURE FAULT IF A PRESSURE > 30 PSI CAN NOT BE MAINTAINED. DO NOT ATTEMPT TO ADJUST THE PRESSURE SWITCH. THE PROPER FIX FOR THIS PROBLEM IS TO INCREASE THE FEED PRESSURE WITH A BOOSTER SYSTEM.

Membranes

The Defender reverse osmosis system comes pre-loaded with Thin Film Composite membranes, unless otherwise specified. General membrane element performance characteristics are listed on the next page.

UV Light Sleeve and Bulb

The Defender reverse osmosis systems UV light will not have the Quartz sleeve and bulb installed. This must be done on site.

1. Remove the quartz sleeve from its packaging, being careful not to touch the length with your hands. The use of cotton or latex gloves is recommended for this procedure as oils from the hands can leave residue on the sleeve and lamp which can ultimately block the UV light from getting to the water.
2. Carefully slide the sleeve into the reactor until you can feel it hit the opposite end of the reactor. Gently push it in to lock it into the internal centering tabs in the far side of the reactor.

CAUTION: Pushing too hard when the sleeve is not aligned can damage the tabs and can break the sleeve.

3. Slide the O-Ring onto the top of the sleeve until it is butted up against the reactor.
4. Hand tighten the provided gland nut over the quartz sleeve onto the threaded end of the reactor. It has a positive stop to prevent over-tightening. A firm force may be required to fully tighten the gland nut.

DO NOT use tools to tighten the gland nut. Hand tight is sufficient.

5. Insert the provided stainless steel compression spring into the quartz sleeve. The spring works with the lamp and lamp connector to create the proper lamp alignment.
6. Remove the lamp from its packaging. Hold the lamp by the ceramic ends, not by the lamp quartz. Remove the lamp key from the lamp's connector and set it aside. Be careful to not touch the key's exposed contacts. Insert the UV lamp into the reactor, being careful not to drop it.

BE SURE to install the UV lamp spring in the quartz sleeve prior to installing the bulb.

7. Install the lamp key into the controller mounted on the front of the Defender. Orient the lamp key so the label is upright and facing you during installation. The key will plug into the port on the right side of the controller.
8. Plug the lamp connector into the lamp. Note the notch for proper alignment. Insert the lamp connector into the gland nut and turn the connector approximately 1/4 turn to lock the connector to the gland nut.



9. Tighten the captive ground screw to the ground lug on the UV reactor to ensure proper grounding.

IMPORTANT! Make sure the quartz sleeve is installed properly and make sure there are no leaks before installing the bulb and powering the UV light.

Membrane Element

Membrane Type : Polyamide Thin-Film Composite	pH Range, Short Term Cleaning (30 Min): 1-13
Maximum Operating Temperature (°F / °C): 113 / 45	Maximum Feed Silt Density Index (SDI): 5
Maximum Operating Pressure (psi / bar): 400 / 27.58	Chlorine / Chloramine Tolerance (ppm): 0
pH Range, Continuous Operation* : 2-11	

*Maximum temperature for continuous operations above pH 10 is 95°F / 35°C

Part Number	Description	Applied Pressure (psi / bar)	Permeate Flow Rate (gpm / m ³ / d)	Nominal Salt Rejection
255-211757	Ultra Low Energy Membrane 4 x 40	80 / 5.52	225 / 0.85	98.50

Warranty Evaluation Test Conditions: Permeate flow and salt rejection based on the following test conditions - 550 ppm, filtered and dechlorinated municipal tap water. 77°F / 25°C, 15% recovery and the specified operating pressure. Minimum salt rejection is 96%. Permeate flows for warranty evaluation may vary +/- 20%. Maximum pressure drop at 13 psig / 0.9 bar

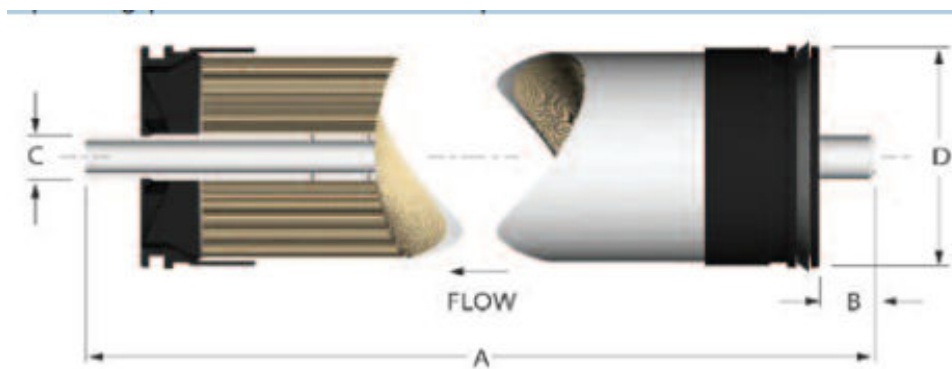

A	B	C	D
40 in / 1016.00 mm	1.1 in / 27.94 mm	0.75 in / 19.05 mm	3.95 in / 100.30 mm

*Fits nominal 4.00" I.D Membrane housings.

Proper start up of reverse osmosis water treatment systems is essential to prepare the membranes for operating service and to prevent membrane damage due to overfeeding or hydraulic shock. Before initiating system start up procedures, membrane pre-treatment, loading of the membrane elements, instrument calibration and other system checks should be completed.

Avoid any abrupt pressure or cross flow variations on the spiral elements during start up, shutdown, cleaning or other sequences to prevent possible membrane damage. During start up, a gradual change from a standstill to operating state is recommended as follows:

- Feed pressure should be increased gradually over a 30 – 60 second time frame.
- Cross flow velocity at set operating point should be achieved gradually over 15 – 20 seconds.
- Permeate obtained from first hour of operation should be discarded.
- Maximum pressure drop across an entire pressure vessel (housing) is 30 psi / 2.1 bar.
- Avoid static permeate side back pressure at all times.

Under certain conditions, the presence of free chlorine, chloramines and other oxidizing agents will cause premature membrane failure. Since oxidation damage is not covered under warranty, the manufacturer recommends removing all oxidizing agents by pre-treatment prior to membrane exposure. Please contact the manufacturer or your supplier for more information. Do not use this initial permeate for drinking water or food preparation. Keep elements moist at all times after initial wetting.

To prevent biological growth during prolonged system shutdowns, it is recommended that membrane elements be immersed in a preservative solution. Rinse out the preservative before use. For membrane warranty details, please contact the manufacturer or your supplier for more information. If operating limits and guidelines given in this product specification sheet are not strictly followed, the warranty will be null and void.

The customer is fully responsible for the effects of incompatible chemicals and lubricants on elements. Use of any such chemicals or lubricants will void the warranty. These membranes may be subject to drinking water application restrictions in some countries: please check the application status before use and sale. The use of this product in and of itself does not necessarily guarantee the removal of cysts and pathogens from water. Effective cyst and pathogen reduction is dependent on the complete system design and on the operation and maintenance of the system.

No freedom from infringement of any patent owned by the manufacturer or others is to be inferred. Because use conditions and applicable laws may differ from one location to another and may change with time, customer is responsible for determining whether products and the information in this document are appropriate for customer's use and for ensuring that customer's workplace and disposal practices are in compliance with applicable laws and other governmental enactments. The claims made may not have been approved for use in all countries. The manufacturer assumes no obligation or liability for the information in this document. **NO WARRANTIES ARE GIVEN; ALL IMPLIED WARRANTIES OF MERCHANTABILITY OR FITNESS FOR A PARTICULAR PURPOSE ARE EXPRESSLY EXCLUDED**

Tank Level and Pre-treatment Lockout Wiring

The Defender system is equipped with two switch closure circuits that control the RO system ON/OFF function. This is a "no voltage" switch closure circuit (dry contact).

Tank Level Input

There is a switch closure circuit used to turn some RO systems on and off when an atmospheric tank float is installed. The float switch wires as follows:

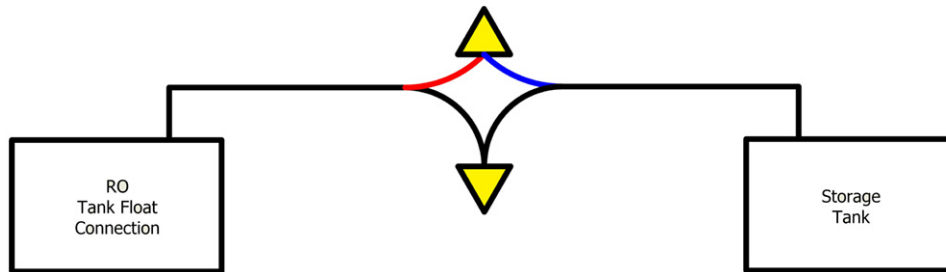

The wires above show color coatings. However, the colors do not matter. There is no voltage to these wires. They just need to be wired in a loop that can open or close when necessary. **BE SURE** to use the blue and black wires only on the float.

IMPORTANT! Do not apply voltage to the tank level input circuit. This will damage the RO system.

Once the float is wired, be sure to remove the shipping ties securing the float. Adjust the float accordingly for your system.



Pre-treatment Lockout Wiring

In some applications, there are backwashing filter units or softeners used as pre-treatment for the RO module. Some of these pre-treatment units may be equipped with a "lockout" output. In this case, these outputs can be wired into the tank Pre-treatment Lockout Inputs. This will shut the RO module down while the backwashing filter or softener is in regeneration / backwash. This option is utilized to ensure there is no untreated water fed to the RO system when a pre-treatment device is in regeneration / backwash. The pre-treatment output switches will be wired as follows.

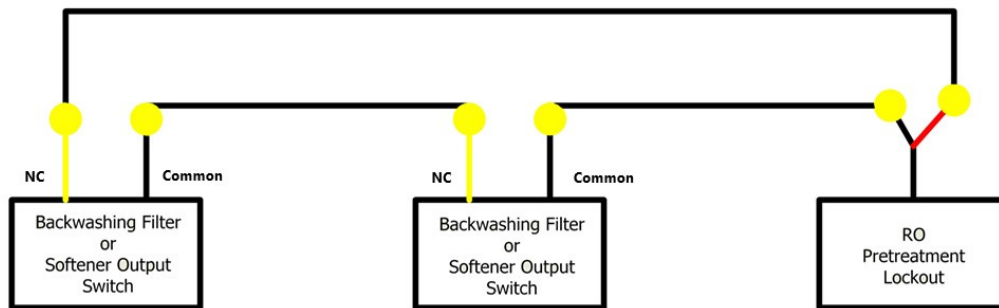

The wires above show color coatings. However, the colors do not matter. There is no voltage to these wires. They just need to be wired in a loop that can open or close when necessary. **BE SURE** to use the Normally Closed (circuit opens when regeneration / backwash starts and closes at the end of all cycles) wires only on the Backwashing Filter or Softener output switch.

IMPORTANT! Do not apply voltage to the Pre-treatment Lockout connection circuit. This will damage the RO system. BE SURE the pre-treatment output switch on the backwashing filter or softener DOES NOT supply power.

Anti-Scalant Filling and Settings

If anti-scalant is used in lieu of a water softener to control hardness, the dose and mix is determined using the feed water analysis, the chemical pump specifications and the RO system operating parameters. The table below can be used in 90% of the applications. However, in some rare cases, the US Water Systems Specialist will have specific guidelines. If this is the case, the US Water Specialist will make it known. Use the following procedure when filling the tank:

1. Fill the tank with 5 gallons of clean water (preferably RO water). Add specified oz of the Hyper-Guard Plus 7000 anti-scalant solution for each gallon of water to the tank using the table provided.
2. Cut the smooth portion of the injection check valve off, up to the male threads. This is to ensure the outlet does not bottom out and restrict flow of the solution.
3. Install the injection check valve in the chemical injection port on the RO system after the sediment filter. This should be labeled with a pipe plug installed.
4. Plug the chemical injection pump into the chemical injection pump female cord labeled "Dosing Pump" on the RO system. This cord is energized when the RO system is operating.
5. Make sure the toggle switch on the injection pump is in the "ON" position.





The anti-scalant pump will operate when the RO is running. This pump should self prime during the start up procedure. The solution tank can be topped off with 10 more gallons of mixed solution once the RO system is online. Be sure to mix the solution correctly when topping off the solution tank. Future tank fills can be done using the RO water produced by the new RO system.

NOTE: it is a good practice to mix the anti-scalant solution weekly to ensure the solution concentration stays consistent.

US Water Hyper-Guard Plus 7000 Anti-Scalant Mixture		
RO GPD Rating	Initial Fill for Entire 15 Gallon Tank	Ongoing Fill Per Gallon of Refill RO Water
2,000	30 oz	2 oz
4,000	39.1 oz	2.6 oz
6,000	49.2 oz	3.3 oz
8,000	58.2 oz	3.9 oz
Based on Hyper-Guard Plus 7000 Anti-Scalant. 3 GPD pump, 15 gallon tank.		
NOTE: Stir the tank weekly to keep the solution from separating.		

RO Start-Up

Adjusting the RO System Flow Rates

1. Be sure the pre-treatment systems have been flushed and put in service. If anti-scalant is being used, be sure to confirm the dose and mix of the solution with the sales rep before starting the system.
2. If possible, remove the pre-filter and fill it with water. This will remove the majority of the air in the system.
3. Make sure the water supply is turned on and that you have a minimum of 30 PSI to the system. The optimal pressure would be 60 PSI.

NOTE: SYSTEM RUNNING PRESSURE CANNOT FALL BELOW 30 PSI

4. Open the concentrate valve completely by turning it counterclockwise. Close the concentrate recycle valve (if applicable) completely by turning it clockwise.
5. Turn the RO system on.
6. Let the system run for 5 - 10 minutes to flush the remaining air out of the filters and membranes.

NOTE: The system may need to be shut off and turned back on several times to flush the air out and for the system to continue to run. This may be increased if the sediment filter is not filled with water first.

7. Check the running inlet pressure. The pressure should be between 40 - 60 PSI (**30 PSI Minimum**) during operation to ensure the system will not shut down due to a low pressure fault.
8. Adjust the system to the designed flow rates without exceeding 150 PSI on the pump / membrane pressure gauge. This adjustment is system and site specific. The concentrate valve, concentrate recycle valve, and the throttle valve on the pump will need to be balanced so the RO meets the designed flow rates for each stream without exceeding 150 PSI on the System Pressure Gauge.

System Size	Targeted Permeate Flow	Concentrate Flow (No Recycle)	Concentrate Flow (With Recycle)	Concentrate Recycle Flow	Maximum System Pressure
2000	1.39 GPM	3 GPM	0.5 GPM	2.5 GPM	150 PSI
4000	2.78 GPM	3 GPM	1 GPM	2 GPM	150 PSI
6000	4.17 GPM	3 GPM	1.5 GPM	1.5 GPM	150 PSI
8000	5.56 GPM	3 GPM	2 GPM	1 GPM	150 PSI

CAUTION: Recycle is not always recommended. If the system is on well water, check with our technical support team first to verify water quality is within operating limits permitting recycle.

WARNING: NEVER EXCEED THE MAXIMUM PRESSURE RATING OF YOUR SYSTEM

Adjust the pump throttle valve and concentrate valve until the correct flow is achieved. For example, DFWHRO-4000 should be adjusted until it produces about 4000 GPD or 2.78 GPM of permeate (product water) at 77°F. The designed flow may be achieved below 150 PSI but it is IMPORTANT not to exceed 150 PSI on the System Pressure when adjusting.

75% Recovery System Adjustment

Turn the concentrate valve clockwise until the permeate flow rate and the concentrate flow rate are at designed standards. Turn the recycle valve until the recycle flow rate is at the desired rate. If necessary, adjust the pump throttle valve, concentrate valve, and concentrate recycle valve until the proper flow rates are achieved **while not exceeding 150 PSI** pump pressure and not reducing the pump pressure below **80 PSI**. The concentrate recycle flow rate and the concentrate flow rate must equate to the minimum flux rate or higher in high flow feeds or damage to the membrane may occur.

Once the flow rates have been adjusted, monitor the system over the first two weeks and make fine adjustments to maintain the proper flow rates. When there is a change in the feed water TDS level or temperature, the flow rates may need to be re-adjusted. The recycle flow rate can be determined using the desired Recovery Rate (75% maximum) and the Permeate Flow Rate. The equation is as follows;

- RO System GPD Rating / 1440 mins (mins in a day) = Permeate Flow Rate GPM
- Permeate Flow GPM / 75% (0.75) = Total Flow GPM
- Total Flow GPM - Permeate Flow Rate GPM = Concentrate Flow GPM
- **Minimum Flux Rate** (determined by membrane size / diameter) GPM - Concentrate Flow Rate GPM = Recycle Flow Rate GPM
- 4.0" Membrane Minimum Flux Rate - 3.0 GPM

Example:

- 2000 GPD System
- 2000 GPD / 1440 Mins = 1.39 GPM Permeate Flow
- 1.39 / 0.75 = 1.85 GPM Total Flow
- 1.85 GPM - 1.39 GPM = 0.46 GPM Concentrate Flow
- 1 (min 2.5" Membrane Flux) - 0.46 GPM = 2.54 GPM Recycle Flow

Once the adjustments are made, the system is operational.

IMPORTANT! Be sure to flush the storage tank as the initial water the RO makes during adjustment is not up to quality. This can usually be done by letting the tank fill for about 50 gallons and emptying the tank twice or directing the permeate water to a drain until the water quality stabilizes.

Operating Do's and Don'ts

DO:

- Change the cartridge filters regularly
- Monitor the system and keep a daily log
- Run the system, as much as possible, on a continuous basis
- Adjust the system recovery to the recommended value
- Always feed the pump with filtered water

DON'T:

- Permit chlorine to enter or be present in the feed water
- Shut down the system for extended periods
- Close the throttle valve completely
- Operate the system with insufficient feed flow
- Operate the pump dry

CAUTION: EXCESSIVE RECYCLING MAY CAUSE PREMATURE FOULING OR SCALING OF THE MEMBRANE ELEMENTS

Low Pressure Switch



The low pressure switch shuts off the system when the feed water pressure drops below 15 PSI, preventing damage to the pump. The system restarts automatically when there is a constant pressure of 30 PSI or more.

NOTE: If you notice the pressure fluctuating and the system cycling off and on, turn the system off and ensure that proper feed flow and pressure are available to the system.

Pump Throttle Valve

This valve is installed as a standard feature on the Defender reverse osmosis system. It provides an adjustment for pump pressure, which will vary as the required system pressure changes. As the feed water temperature decreases, and / or the feed water TDS increases, the system will require a higher operating pressure to produce the specified permeate flow. For example ; A system installed in Florida may provide the specified permeate flow at 100 PSI ; however the same system installed in Maine with much colder feed water may require 150 PSI to produce the same amount of permeate.

CAUTION! *Never exceed 150 PSI*

Adjusting Throttle Valve

To decrease the pressure, turn the the handle clockwise. To increase the pressure, turn the handle counterclockwise

DECREASE PRESSURE



INCREASE PRESSURE

Membrane Removal & Replacement

Replacing membranes in the pressure vessels is an easy process if you have the proper information and tools at hand. Please refer to the following instructions when removing and replacing membrane elements.

WARNING: ALL PRESSURE GAUGES MUST READ ZERO BEFORE PROCEEDING. BEFORE ATTEMPTING, DISCONNECT THE POWER FROM THE SYSTEM AND BLEED ALL WATER PRESSURE FROM THE SYSTEM!

1. Remove the end caps from the top of the membrane housings.
2. Remove the membrane bag containing the membrane element from the shipping box.

WEAR GLOVES FOR THE FOLLOWING STEPS IN ORDER TO NOT CONTAMINATE THE MEMBRANE

3. Cut the bag open as close as possible to the seal at the end of the bag so the bag may be reused if necessary.
4. Make sure that all parts are clean and free from dirt. Examine the brine seal and permeate tube for nicks or cuts. Replace the O-rings or brine seal if damaged.

Flow directions should be observed for installation of each element into each housing.

As time progresses, the efficiency of the membrane will be reduced. In general, the salt rejection does not change significantly until two or three years after installation when operated on properly pretreated feed water. The permeate flow rate will begin to decline slightly after one year of operation but can be extended with diligent flushing and cleaning of the system. A high pH and / or precipitation of hardness can cause premature loss in rejection.

Replacing the Membrane Element

WARNING: THE BRINE SEAL MUST BE IN THE SAME POSITION FOR EACH MEMBRANE ELEMENT HOUSING. MARK EACH HOUSING PRIOR TO REMOVING THE MEMBRANE ELEMENTS. THE BRINE SEAL IS A RUBBER SEAL THAT PROTRUDES ON ONE SIDE OF THE MEMBRANE AND IS ALWAYS ON THE FEED SIDE OF THE MEMBRANE ELEMENT.

1. Remove one membrane element at a time from the membrane element housings, from the top of the housing. Needle nose pliers may be necessary to pull the old membrane element out of the membrane element housing.
2. Lubricate the brine seal with non petroleum based lubricant, Silicone DC 111.
3. Install the brine seal side of the membrane element first. When the housings have a direction of flow from bottom to top, the brine seal should be located at the bottom of the housing.
4. At a slight angle, insert the membrane while slightly rotating the element and being careful not to tear or flip the brine seal. A slow twisting motion should be used to insert the membrane element to ensure the brine seal stays in place. Re-lube the brine seal if necessary.
5. With a smooth and constant motion, push the membrane element into the housing so the brine seal enters the housing without coming out of the brine seal groove.
6. Re-install the end caps by gently twisting the end cap while pushing it onto the housing. Ensure that you do not pinch or fatigue any O-rings while re-installing the end plug. Push the end plug on until the outer diameter of the plug is flush with the outer diameter of the membrane housing.
7. Reconnect any fittings that may have been disconnected when the membrane element housings were disassembled.
8. To start up the system, please refer to the Initial Start-Up section of this manual.

CAUTION: WET MEMBRANES ARE SHIPPED IN A PRESERVATIVE SOLUTION. THE MEMBRANES MUST BE FLUSHED FOR AT LEAST 1 HOUR TO REMOVE THE PRESERVATIVE FROM THE MEMBRANE. DISCARD ALL OF THE PERMEATE AND CONCENTRATE WHICH IS PRODUCED DURING THE FLUSH PERIOD.

Flushing the System

The system should be flushed weekly to remove sediment from the surface of the membranes. To manually flush the system, follow the steps below:

1. The system must be operating during the flush procedure.
2. Fully open the concentrate valve.
3. Allow the system to run for 10 to 20 minutes.
4. After 10 to 20 minutes, close the concentrate valve to its previous setting. Ensure the proper concentrate flow rate is going to the drain.
5. The system is now ready to operate.

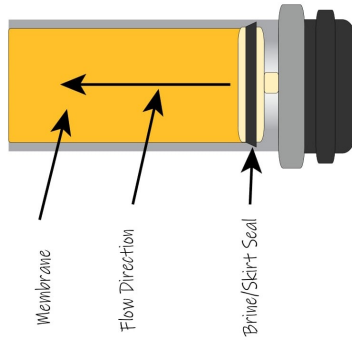

The membrane inlet is on the brine/skirt seal side. The skirt seal can be on the top or the bottom depending on how the membrane housing has been installed. In a series configuration the membranes will alternate from bottom to top and back.

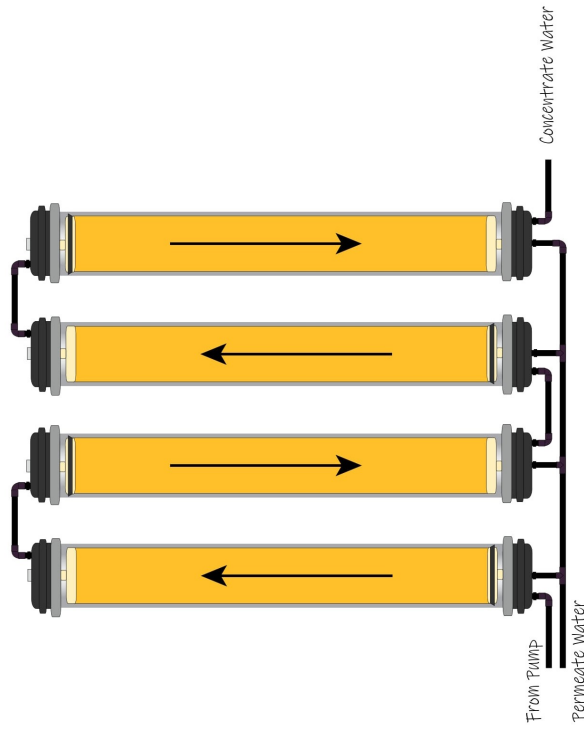

Corporate Headquarters
12206 Coopers, Chicago, IL 60625-4
900-608-6382
www.uswatersystems.com

System: DTR600-700	Category: Engineering
Scale: None	
Drawn By: C. Dierke	Completion Date: March 16, 2022
File: S016044	Drawing ID: 6000-0000-0000-0000

Temperature Correction Factors For Membranes

Find the temperature correction factor (TCF) from the table below. Divide the rated permeate flow at 77°F by the temperature correction factor. The result is the permeate flow at the desired temperature.

Temperature °F (°C)	Temperature Correction Factor	Temperature °F (°C)	Temperature Correction Factor	Temperature °F (°C)	Temperature Correction Factor	Temperature °F (°C)	Temperature Correction Factor
50.0 (10.0)	1.711	58.5 (14.7)	1.437	69.1 (20.6)	1.164	77.5 (25.3)	0.991
50.5 (10.3)	1.692	59.0 (15.0)	1.422	69.6 (20.9)	1.152	78.1 (25.6)	0.982
51.1 (10.6)	1.673	59.5 (15.3)	1.406	70.0 (21.1)	1.144	78.6 (25.9)	0.974
51.6 (10.9)	1.654	60.1 (15.6)	1.391	70.5 (21.4)	1.132	79.0 (26.1)	0.968
52.0 (11.1)	1.642	60.6 (15.9)	1.376	71.1 (21.7)	1.120	79.5 (26.4)	0.959
52.5 (11.4)	1.624	61.0 (16.1)	1.366	71.6 (22.0)	1.109	80.1 (26.7)	0.951
53.1 (11.7)	1.605	61.5 (16.4)	1.351	72.0 (22.2)	1.101	80.6 (27.0)	0.943
53.6 (12.0)	1.588	62.1 (16.7)	1.337	72.5 (22.5)	1.090	81.0 (27.2)	0.937
54.0 (12.2)	1.576	62.6 (17.0)	1.323	73.0 (22.8)	1.078	81.5 (27.5)	0.929
54.5 (12.5)	1.558	63.0 (17.2)	1.313	73.6 (23.1)	1.067	82.0 (27.8)	0.921
55.0 (12.8)	1.541	63.5 (17.5)	1.299	74.1 (23.4)	1.056	82.6 (28.1)	0.913
55.6 (13.1)	1.524	64.0 (17.8)	1.285	74.5 (23.6)	1.049	83.1 (28.4)	0.905
56.1 (13.4)	1.508	64.6 (18.1)	1.272	75.0 (23.9)	1.038	83.5 (28.6)	0.900
56.5 (13.6)	1.496	65.1 (18.4)	1.258	75.6 (24.2)	1.028	84.0 (28.9)	0.892
57.0 (13.9)	1.480	66.0 (18.9)	1.236	76.1 (24.5)	1.017	84.6 (29.2)	0.884
57.6 (14.2)	1.464	66.6 (19.2)	1.223	76.5 (24.7)	1.010	85.1 (29.5)	0.877
58.1 (14.5)	1.448	68.0 (20.0)	1.189	77.0 (25.0)	1.000	85.6 (29.8)	0.869

If a system is rated to produce 5 GPM of permeate water at 77°F, the same system will produce more water at a higher temperature. It will also produce less water at a lower temperature. Use the temperature correction table to obtain the correct flow.

Replacing the Lamp

1. Ensure the system is powered down and the UV controller is turned off.
2. Remove the lamp connector from the reactor by pushing the lamp connector in and turning it 1/4 turn counter-clockwise. Disconnect the lamp connector from the lamp.
CAUTION: The lamp may be hot.
3. Remove the existing lamp key from the UV controller and discard it.
4. Remove the new lamp from its packaging, taking care not to touch the lamp itself. Remove the lamp key from the lamp's connector and set it aside. Insert the new lamp into the UV reactor.
NOTE: The use of cotton gloves is recommended while handling UV lamps.
5. Install the new lamp key into the controller, making sure it is turned upright and the label is facing you during installation. The key will plug into the lamp key port on the right side of the controller.
6. Plug the lamp connector into the lamp. Note the notch for proper alignment. Insert the lamp connector into the gland nut and turn the connector approximately 1/4 turn to lock the connector to the gland nut.



7. Proceed to plug the UV Ballast back into the outlet and let the system run through diagnostic steps. Please refer to the Diagnostic Steps portion of the manual for full details.

Cleaning/Replacing the Quartz Sleeve

Depending on the water quality, the quartz sleeve may require periodic cleaning. At a minimum, the quartz sleeve should be cleaned on an annual basis. The following steps outline a basic cleaning procedure.

1. If a bypass assembly is installed, shut the inlet valve off to prevent water flow through the system. Otherwise, turn off the main water inlet valve (and / or turn off the water pump).
2. Shut down the Defender system and ensure power is not running to the UV controller.
3. Release water pressure by opening a downstream faucet and then close the outlet shut-off valve (if any). If there is no outlet shut-off valve, expect water to drain from the system as the head pressure in the system will cause the water to flow back down.

Defender systems also have a drain plug installed on the bottom of the UV reactor. After releasing the water pressure at a faucet, remove this plug to ensure the system is fully drained.

CAUTION: If using the Defender system with a water reservoir tank, be sure to close the supply valve leading away from the tank to prevent gravity fed water from shooting through the UV during the replacement process.

4. Remove the captive ground screw from the ground lug on the UV reactor.
5. Remove the lamp connector from the reactor (gland nut) by pushing the connector in and turning it 1/4 turn counter-clockwise. Disconnect the lamp connector from the lamp. **CAUTION: The lamp may be hot.**
6. Being careful to touch only the ceramic ends, remove the lamp out of the reactor.
7. Unscrew the gland nut from the reactor exposing the end of the quartz sleeve.
8. Remove the quartz sleeve and O-ring by **gently twisting and pulling** the quartz sleeve.
9. Using a soft, lint-free cloth or towel, wipe the sleeve down using a commercial scale cleaner (i.e. CLR or Lime-A-Way). Alcohol wipes will work as well. This removes scaling or iron deposits that may be on the outside of the quartz sleeve. Be careful not to get any moisture or liquids inside of the sleeve.
10. Dry the sleeve with a separate cloth.
11. Install the clean tube into the UV Reactor. Install the O-Ring and gland nut. .

System Flow Diagram

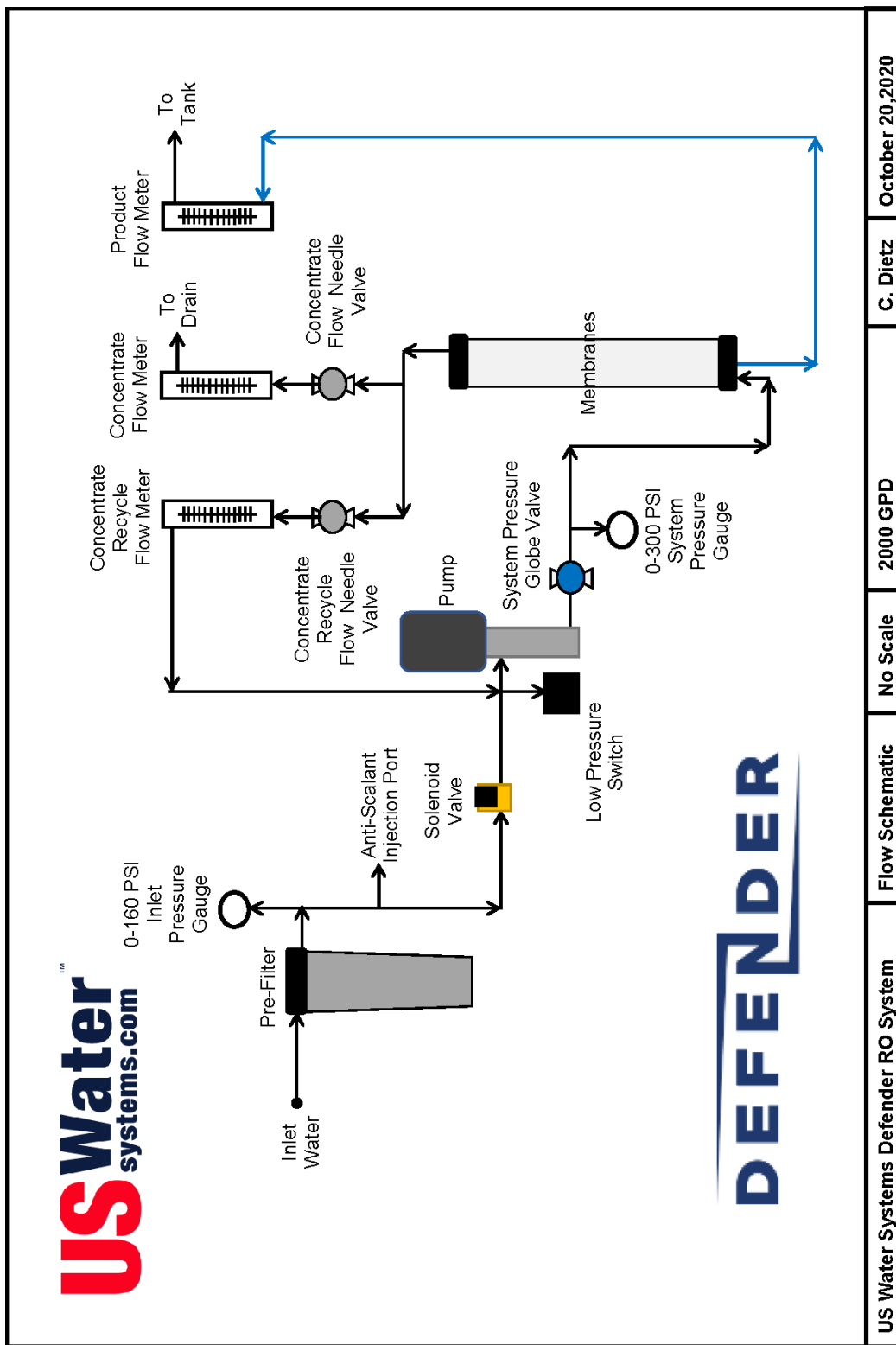

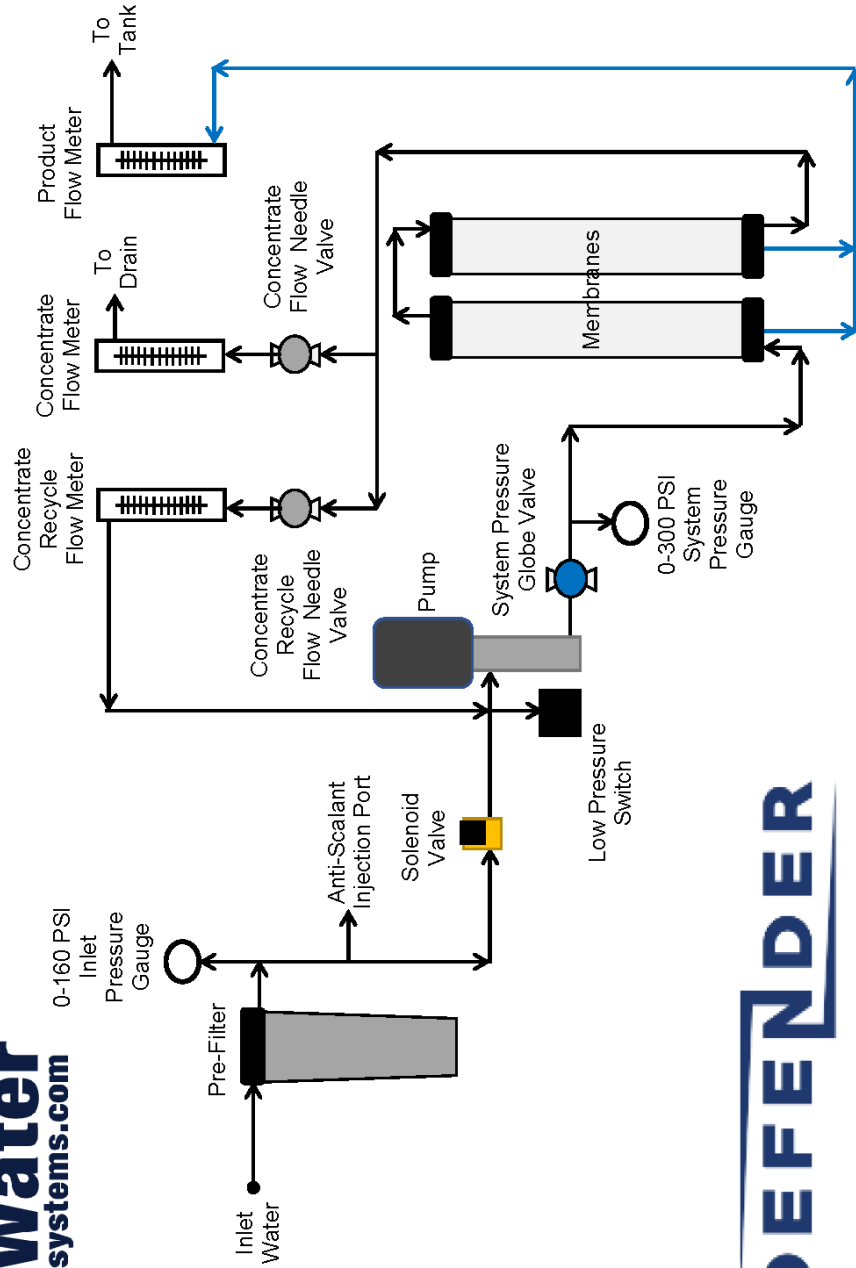

DEFENDER

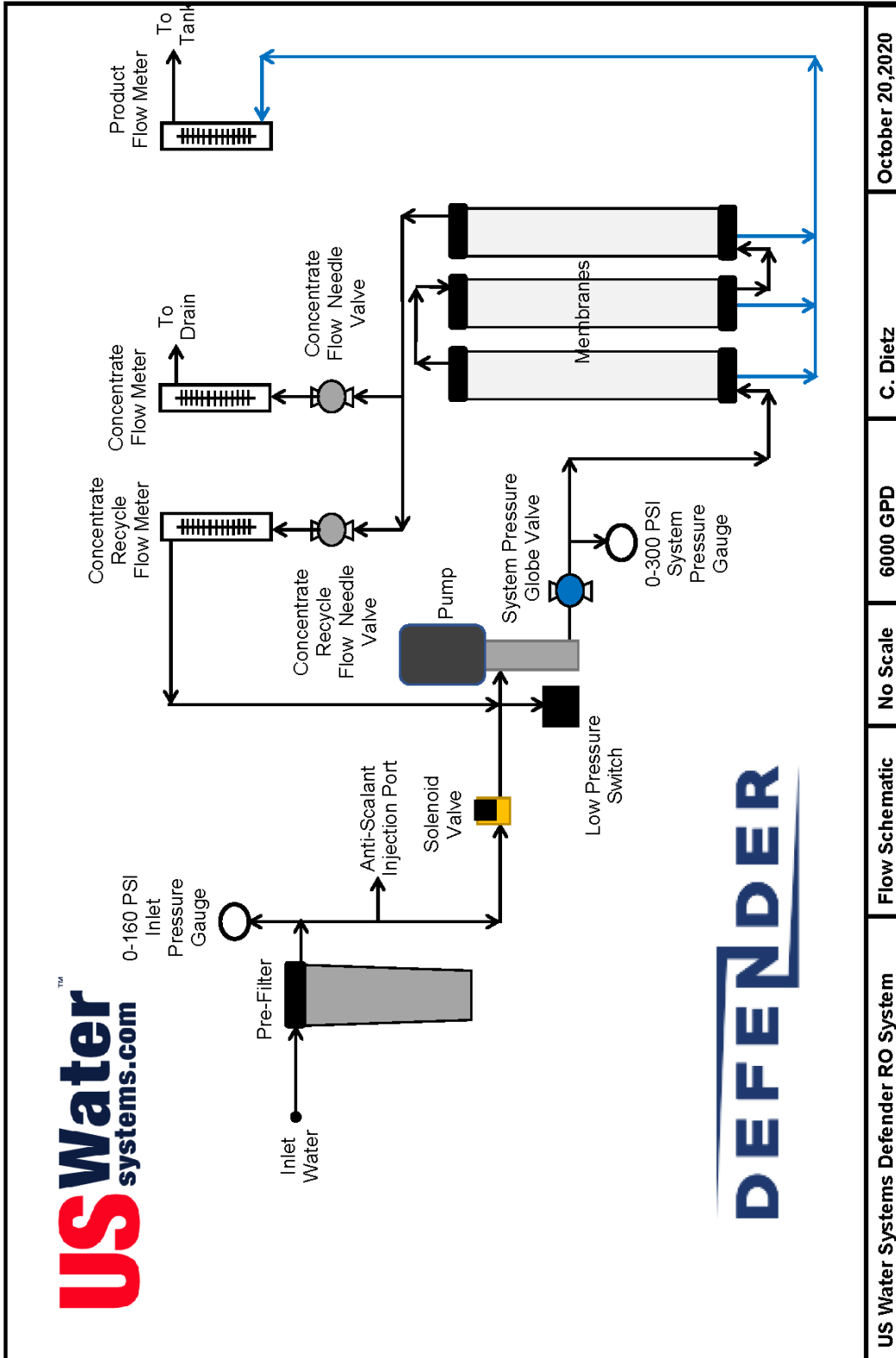

US Water Systems Defender RO System	Flow Schematic	No Scale	6000 GPD	C. Dietz	October 20, 2020
-------------------------------------	----------------	----------	----------	----------	------------------

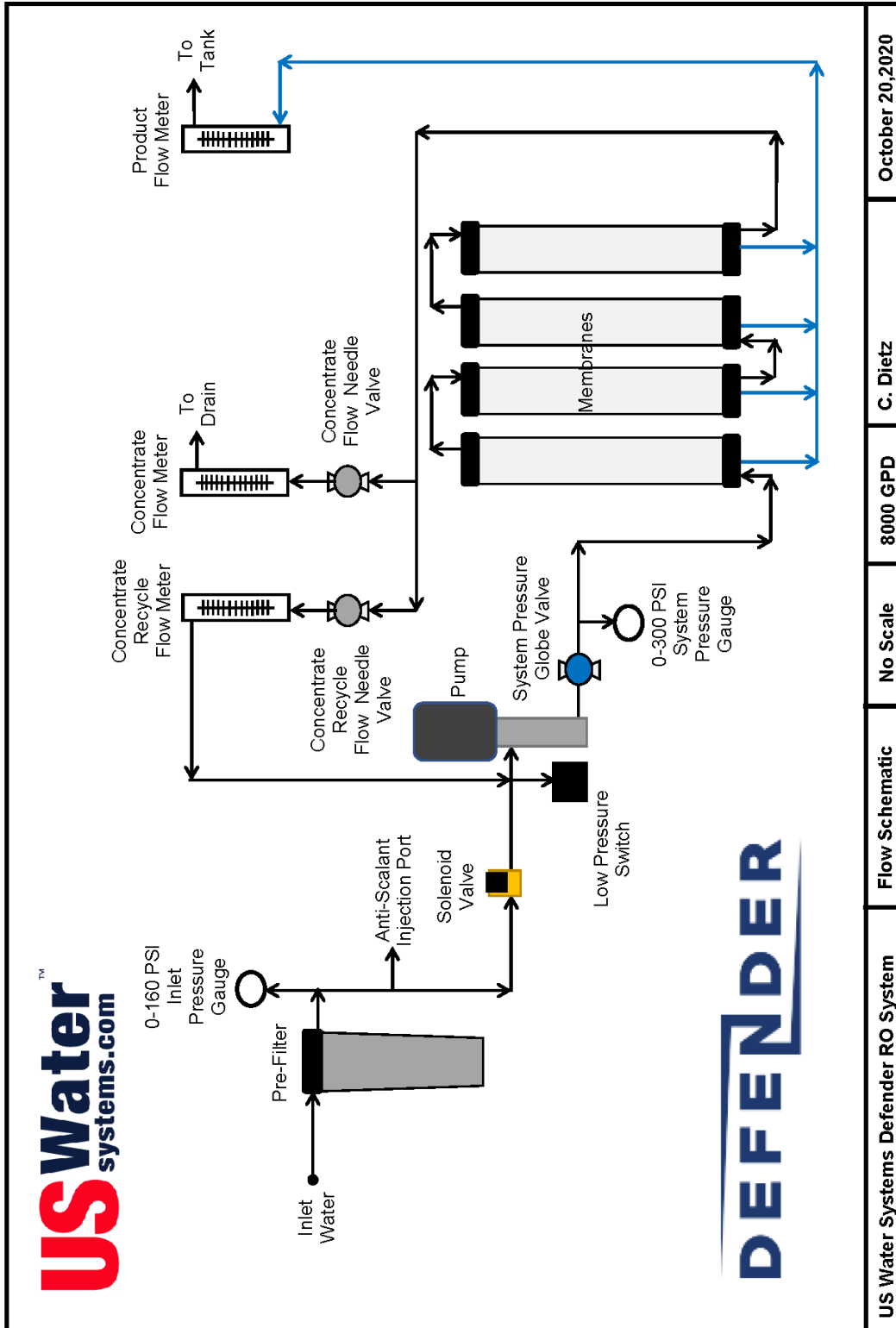

Typical System Layout

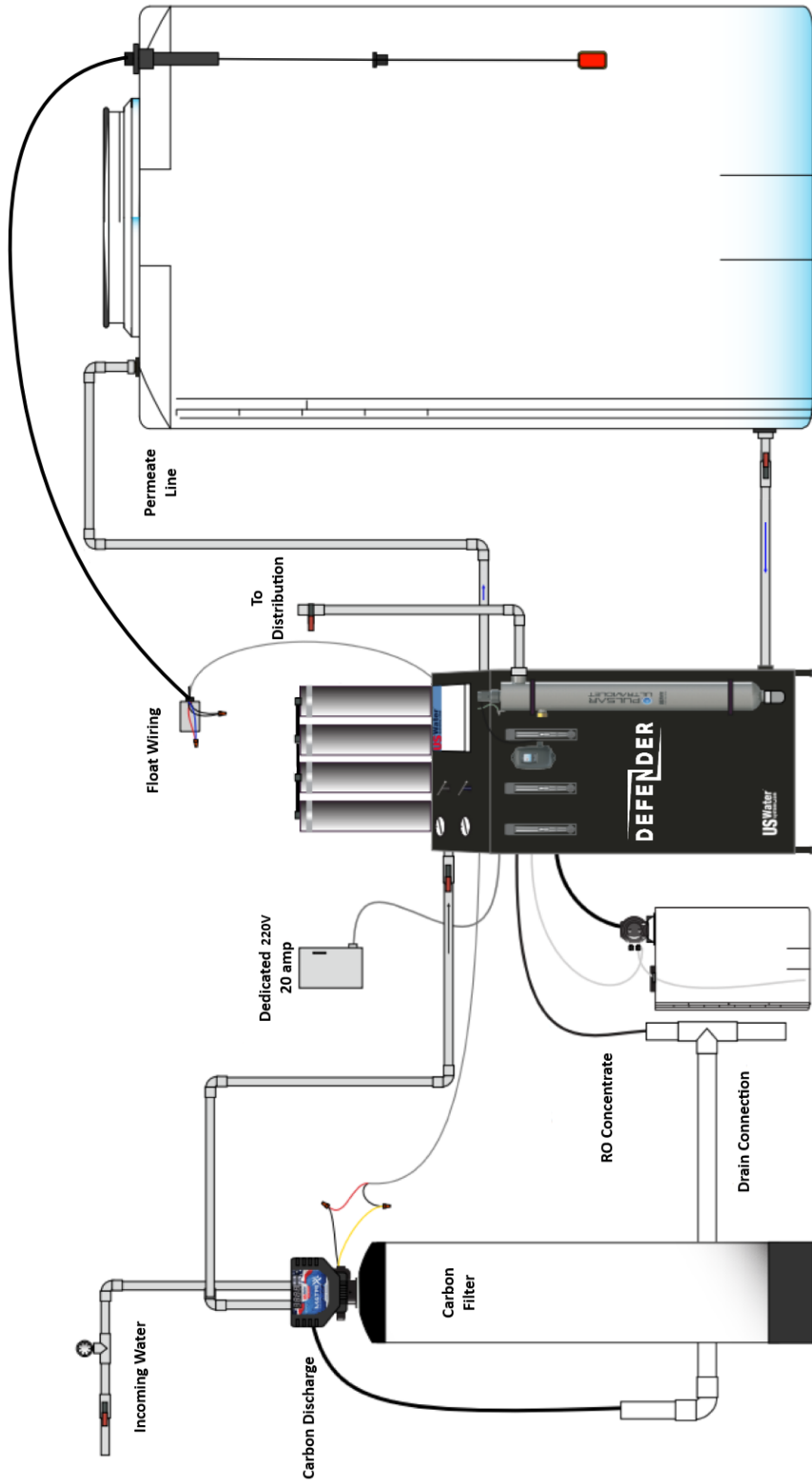

US Water Defender - Whole House - 8000 GPD | Example Flow | No Scale | October 20, 2020

Controller Programming Options

The US Water Systems Series US100 controller is a state of the art control system for commercial and industrial reverse osmosis systems. The Series US100 combines features that have not previously been available in one compact unit.

The Series US100 is a microprocessor controlled system that can monitor pressure and level switches. A TDS monitor / controller with adjustable limit is an integral part of the Series US100. The Series 100 controller displays system status and sensor and switch input status using a status LED and a 3 digit LED display.

SPECIFICATIONS

- **Power:** 220 VAC - 15+10%, 50/60Hz, 6 Watts
- **Environment:** -22°F to 140°F, 0-95% RH, noncondensing
- **Enclosure:** 7.6" x 4.6" x 2.4" (193mm x 117mm x 61 mm)
- **Display:** 3 digit red LED
- **Front Panel:** Overlay with LED window, status LED, water quality LED, power and setpoint switches
- **Switch Inputs, Dry Contact:**
 - Pressure Fault
 - Pretreat Lockout
 - Tank Full
- **Relay Outputs:**
 - RO Pump Relay - 220VAC, 1HP
 - Inlet Valve Relay - 220VAC, 5A
 - Flush Valve Relay - 220VAC, 5A
 - Relays supply same output voltage as board power (220 VAC)
 - 20A maximum total load for all outputs (Based on a service factor of 1.0)
- **Cell:** TDS cell with 3 digit display - 0-1000 PPM. Wetted parts ABS and 316SS, 3/4" NPT, 300 PSI Max.



FRONT PANEL CONTROLS AND INDICATORS

- **LED DISPLAY** - Shows status of system and water quality
- **STATUS LED** - Shows operating status of unit
- **WATER QUALITY LED** - Green if OK, Red if above limit
- **POWER KEY** - Places controller in operating or standby mode
- **SETPOINT KEY** - Places display in mode to display current setpoint
- **SP** - Setpoint adjustment screw
- **CAL** - Calibration adjustment screw

SYSTEM OPERATION

The unit has 2 modes of operation, a standby mode and an operating mode. In the standby mode, the unit is effectively off. All outputs are turned off and the display shows OFF. In the operating mode, the unit operates automatically. All inputs are monitored and the outputs are controlled accordingly. Pressing the Power key will toggle the unit from standby to operate or from operate to standby. If power is removed from the unit, when power is reapplied, the unit will restart in the mode it was in when power was removed.

Display and Status Indicators

The display is a 3 digit display. System operating status, the TDS reading and the TDS setpoint are shown on this display. A red / green LED indicates the system status in conjunction with the display. Refer to the table below for the description of the operation , display and LED.

CONDITION	DISPLAY	STATUS LED
RO OFF	OFF	
RO START DELAY	---	
RO OPERATING		STEADY GREEN
TANK FULL	FUL	
TANK FULL RESTART	FUL	SLOW FLASH GREEN
PRETREAT LOCKOUT	PL	
FLUSH	FLS	
PRESSURE FAULT	PF	FLASHING RED
PF AUTO RESET	PF	
PF AUTO RETRY	PF	STEADY RED

RO Start Delay

When the controller is placed in the operating mode or restarts from a shut down condition, the inlet valve will open and a 5 second time delay will start. During the delay, - - - will show on the water quality display. After this delay, the RO pump will start. The water quality display will now show the current water quality. The status lamp will show steady green.

Pressure Fault

If the pressure fault input is active for 2 seconds, a pressure fault condition will occur. This will cause the controller to shut down. PF will show on the water quality display and the status lamp will flash red. To clear the pressure fault, press the power key twice.

Tank Full

If the tank full input is active for 5 seconds, the controller will shut down for a tank full condition. The water quality display will show FUL. When the tank full condition clears, the unit will restart after the selected restart delay.

Pretreat Lockout

If the pretreat lockout input is active for 2 seconds, the controller will shut down for a pretreat lockout condition. The water quality display will show PL. When the pretreat lockout condition clears, the unit will restart.

Water Quality Display

The water quality display shows the current water quality when the controller is operating normally and status messages when the controller is shut down. The water quality display is 0 - 999 PPM. If the water quality is above 999, the display will show ^ ^ ^. If the water quality is below the setpoint, the water quality lamp will be green. If the water quality is above the setpoint, the water quality lamp will be red.

Water Quality Setpoint

The water quality setpoint can be adjusted from 0 - 999. If set to 999, the water quality lamp will always remain green. To set the water quality setpoint, press the Setpoint key. The display will alternate between the setpoint and SP. Use a small screwdriver to adjust the SP adjustment to the desired setpoint value. Press the Setpoint key to return the display to the water quality display.

Calibration

To adjust the calibration of the water quality, measure the water with a meter calibrated to a known standard. Using a small screwdriver, adjust the CAL adjustment to get the correct reading on the display.

Electrical Schematic

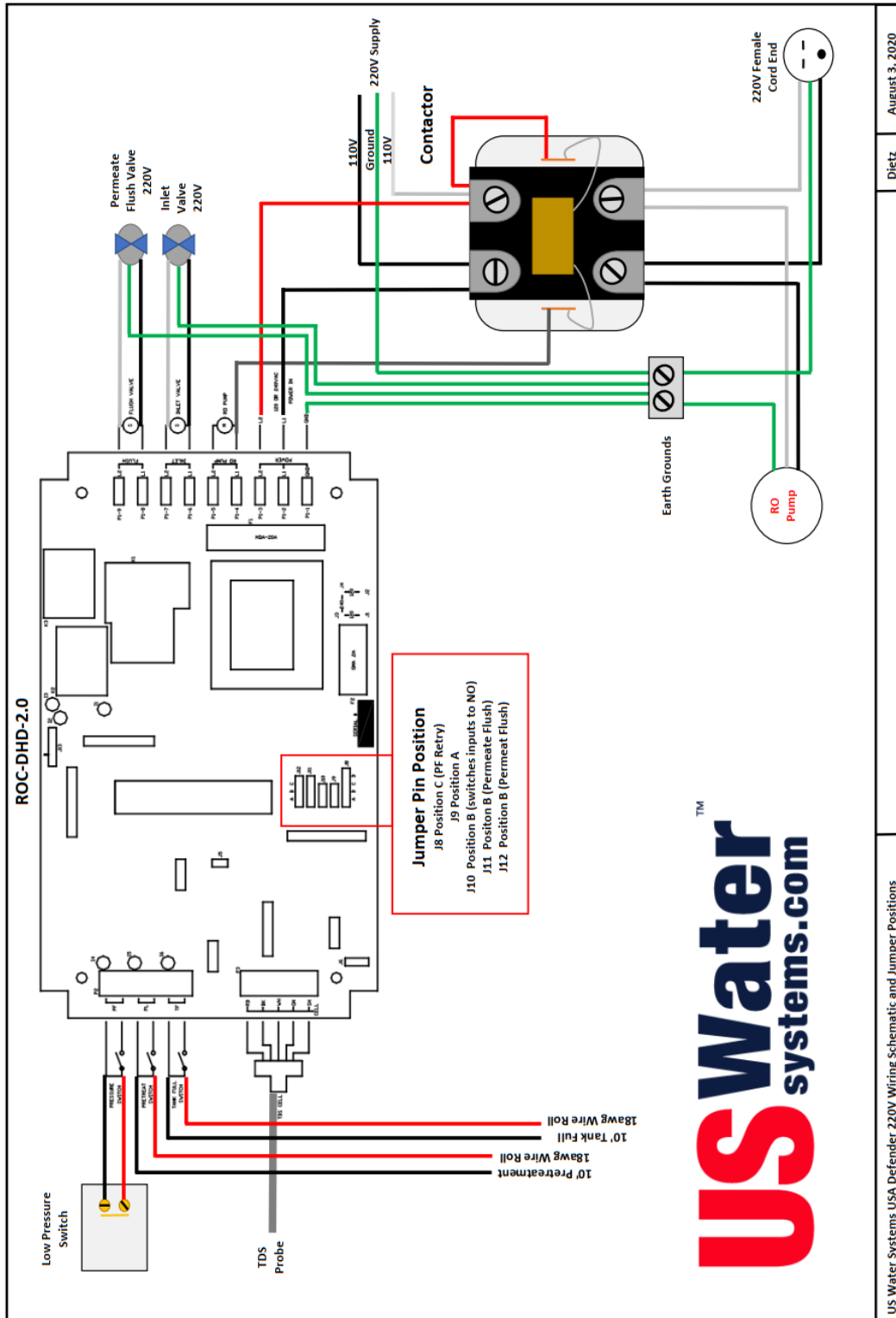

US Water Systems USA Defender 220V Wiring Schematic and Jumper Positions

Dietz

August 3, 2020

Glossary of Terms

The RO system is designed to operate at specified flow rates to ensure longevity of the membranes and performance. It is best to set the RO system to operate at its designed flow rates but, in some cases due to feed water temperature and TDS (total dissolved solids) levels, the designed flow rates may not be achievable. Please see the definitions below to understand the adjustment procedure and the RO system:

- **Permeate:** The clean water being produced by the RO system.
- **Concentrate:** The dirty water being rejected from the RO system to the facility drain.
- **Concentrate Recycle:** The rejected concentrate water that is returned to the pump inlet to be re-processed through the RO system.
- **Rejection Rate:** The percentage of contaminants being rejected by the RO system. This can be figured by taking the incoming TDS value and the Permeate TDS value and using those measurements to do an efficiency calculation. The calculation is as follows: $IN - OUT / IN * 100 = \% \text{ of Rejection}$.
- **Recovery Rate:** The amount of feed water that is being used and not wasted to the drain. This rate is fixed on standard systems. Systems with a concentrate recycle feature can be adjusted to a specified recovery rate. The maximum recovery rate that should be targeted is 75%.
- **Flow Meter:** There are 3 flow meters on the system. These flow meters are called rotometers. There is a stainless steel meniscus that floats in a glass block to a specific level that can be measured using the scale on the glass blocks. The flow meters have a gallons per minute scale and a liters per minute scale. The value should be read at the top of the stainless steel meniscus.
- **Pre-Filter Gauges:** There are two gauges on the pre-filters that are used to monitor the inlet pressure and the pressure drop across the pre-filters on the RO system. When there is a 10 PSI differential in these readings, the pre-filters should be changed. If either of these pressures fall below 30 PSI while the system is running, the system will shut down due to a low pressure fault. This is usually indicated by a red LED light illuminated or digital display indicating a pressure fault. This system should not be operated with low pressure. The low pressure switch should not be adjusted to a lower pressure or the RO booster pump could be damaged.
- **Pump Pressure Gauge:** This gauge is on the front of the RO system and is used to determine the system operating/membrane pressure. This reading is important when adjusting the RO system.
- **Pump Throttle Valve:** There is an adjustment valve on the RO system booster pump. This will either be a slotted adjustment screw on the smaller systems or a gate valve on the larger systems. This valve is used to adjust the pump pressure.
- **Concentrate Valve:** This valve is used to regulate the amount of water that is being directed to the drain.

- **Concentrate Recycle Valve:** This is the valve used to control the amount of concentrate water that is returned to the pump to be recycled through the system.
- **Flux Rate:** The rate of flow across the membranes in the RO system. This rate must be maintained or contaminants can precipitate on the membranes and cause them to fail prematurely.

Warranty

Lifetime Warranty on Tanks - US Water Systems, Inc. will replace any Anti-Scalant Tank or 140 Gallon Storage Tank which fails for the lifetime of the original purchaser, provided the failure is due to a defect in material or workmanship. No warranty is made with respect to defects or damage due to neglect, misuse, alterations, accident, misapplication, physical damage, installation on water quality outside guidelines for system or damage caused by fire, acts of God, or freezing.

Two-Year Warranty - US Water Systems will replace any component (not including consumables*) which fails for two (2) years from the original date of purchase by the original purchaser, provided the failure is due to a defect in material or workmanship. No warranty is made with respect to defects or damage due to neglect, misuse, alterations, accident, misapplication, physical damage, installation on water quality outside guidelines for system or damaged caused by fire, acts of God, or freezing. *Pre-Filters, Membranes, UV Bulb and Sleeve, tubes in chemical pump

Pre-Treatment Warranty - Pre-treatment components shall carry the same warranty as each component product carries individually, such as Lifetime Warranty on tanks.

General Provisions

Purchaser must use Genuine US Water Filters, Membranes, UV Parts and Anti-Scalant in order for Warranty to be valid. US Water Systems assumes no responsibility for subsequent or consequential damages,

labor or expense incurred as a result of a defect or for failure to meet the terms of these guarantees because of circumstances beyond our control. Installation workmanship failure is not covered under warranty. Damage caused by environmental conditions such as, lightning strikes, humidity or heat will not be covered under warranty.

These warranties are in lieu of all other warranties expressed or implied, and we do not authorize any person to assume for us any other obligation on the sale of this water conditioner. No responsibility is assumed for delays or failure to meet these warranties caused by strike, government regulations or other circumstances beyond the control of **US WATER SYSTEMS, INC.** This warranty does not apply to any commercial or industrial installations or to any part of the water conditioner which has been subjected to misuse, neglect, alteration or accident; or to any damage caused by fire, flood, freezing, Acts of God, or any other casualty, or if the original serial numbers have been removed.

TO OBTAIN WARRANTY SERVICE, CALL OR WRITE: US WATER SYSTEMS, INC. 1209 COUNTRY CLUB ROAD INDIANAPOLIS, IN 46234 (800) 608-USWA. ANY IMPLIED WARRANTIES OF FITNESS OR MERCHANTABILITY ARE LIMITED TO THE TERMS OF THIS EXPRESSED WARRANTY AND THERE ARE NO WARRANTIES WHICH EXTEND BEYOND THOSE HEREIN. US WATER SHALL NOT BE LIABLE FOR ANY INCIDENTAL OR CONSEQUENTIAL DAMAGES.

SOME STATES DO NOT ALLOW THE EXCLUSION OR LIMITATIONS OF INCIDENT-

TAL OR CONSEQUENTIAL DAMAGES SO THE ABOVE LIMITATION MAY NOT APPLY TO YOU. THIS WARRANTY GIVES YOU SPECIFIC LEGAL RIGHTS, AND YOU MAY ALSO HAVE OTHER RIGHTS WHICH VARY FROM STATE TO STATE.